

Version:  
January 12, 2017



# TOKEN

## **(LRC) Metal Strip Chip Current Sense Resistor**

**Token Electronics Industry Co., Ltd.**

**Taiwan:** No.137, Sec. 1, Zhongxing Rd., Wugu District,  
New Taipei City, Taiwan, R.O.C. 24872  
Tel: +886 2981 0109 Fax: +886 2988 7487

**China:** 12F, Zhong Xing Industry Bld., Chuang Ye Road,  
Nan Shan District, Shen Zhen City,  
Guang Dong, China 518054  
Tel: +86 755 26055363; Fax: +86 755 26055365

[Web: www.token.com.tw](http://www.token.com.tw)

[Email: rfq@token.com.tw](mailto:rfq@token.com.tw)



**▶ Product Introduction**

**Token (LRC) metal strip current sense chip resistor save space, time, and cost.**

**Features :**

- Low TCR  $\pm 50\text{PPM}/^\circ\text{C}$ ,  $\pm 100\text{PPM}/^\circ\text{C}$ .
- High Wattage Rating Up to 3W.
- Customized Resistance Available.
- Resistance Values from  $0.5\text{m}\Omega$  to  $15\text{m}\Omega$ .
- Without Laser Trimmed with Very Low Inductance.

**Applications :**

- For NB power management.
- For MB power management.
- For Monitor power management.
- SWPS: DC-DC converter, Charger, Adaptor.

Providing design engineers with an economical low Ohmic value, metal strip current sense surface mount resistor with high quality performance, Token Electronics LRC Series is suitable for applications in the automotive sector for applications that require high power handling (Up to 3W) and low resistance  $0.5\text{m}\Omega$ .

From a certified supplier offering the automotive quality, Token's LRC Series gives all round superior performance for current sensing in lamp detection, mirrors, window lift, steering and seat controls.

As a first instance, the LRC Series displays enhanced power handling capabilities, against other technologies.

Thermal conductivity is important for chip resistors - little heat is dissipated directly into the air, and instead, is conducted out through the solder pads.

The heat generated from the specially constructed LRC resistor is more readily dispersed, therefore preventing localized heating, which contributes to TCR and thermal EMF errors, premature aging and possible scorching of the PC board.

The current sensing resistors (LRC) are rated for ambient operation from  $-55^\circ\text{C}$  to  $+170^\circ\text{C}$ . The LRC Series is RoHS compliant and lead free.

Need more detail information about (LRC), please link to Token official website "[Current Sense Resistors](#)". Contact us with your specific needs.



## Construction & Dimensions

### 2512 Construction & Dimension (LRC) (Unit: mm)

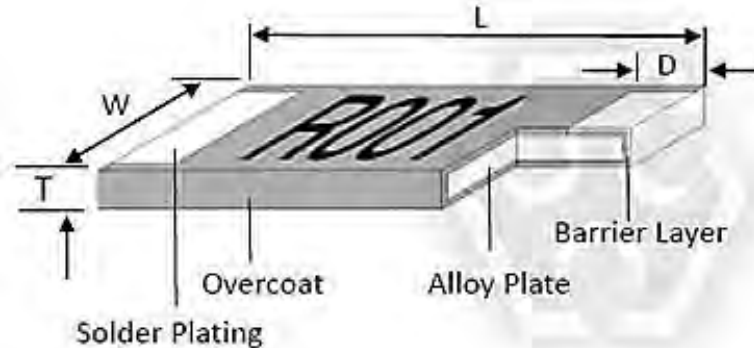

Black 2512 - Wave or IR reflow soldering

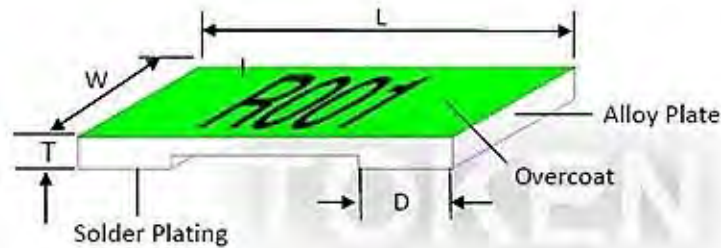

Green 2512 - IR reflow soldering only

### 1206 & 2010 Construction (LRC)

Type	Material
0M50 ~ R003	Manganese, Copper
3M5 ~ R010	Aluminum, Iron, Chromium

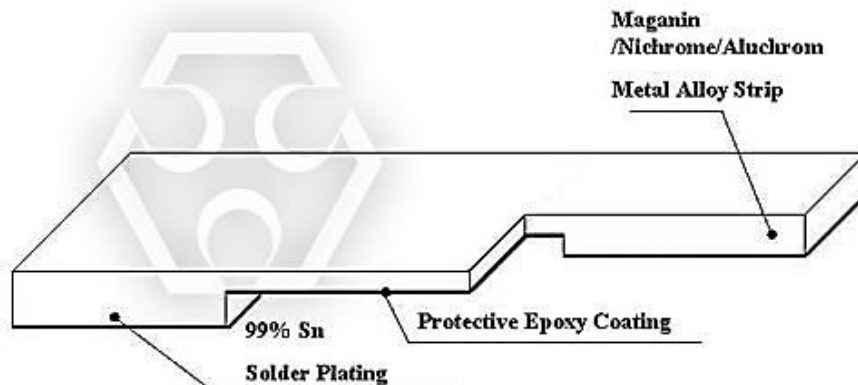

1206 & 2010 Construction

## Chip 2512, 2010, 1206 Dimensions (LRC)

Type	Resistance (mΩ)	L(mm)	W(mm)	T(mm)	D(mm)	Weight(g) / 1000pcs
LRC06*TF0M50	0.50	3.20±0.25	1.60±0.10	0.60±0.20	1.35±0.25	22.6
LRC06*TD0M75	0.75	3.20±0.25	1.60±0.10	0.60±0.20	1.23±0.25	22.6
LRC06*T*****	1.0, 3.5, 4.0, 5.0, 6.0	3.20±0.25	1.60±0.10	0.60±0.20	1.10±0.25	22.6
LRC06*T*****	2.0, 3.0, 10	3.20±0.25	1.60±0.10	0.60±0.20	0.60±0.25	22.6
LRC06*T*****	1.2, 1.5, 7.0, 8.0, 9.0	3.20±0.25	1.60±0.10	0.60±0.20	0.90±0.25	22.6
LRC10*TEA0M50	0.5	5.08±0.25	2.54±0.15	0.60±0.20	2.17±0.25	42.3
LRC10*TDA0M75	0.75	5.08±0.25	2.54±0.15	0.60±0.20	2.04±0.25	42.3
LRC10*TDAR001	1.0	5.08±0.25	2.54±0.15	0.60±0.20	1.84±0.25	42.3
LRC10*TDA****	2.0, 6.0, 7.0, 8.0	5.08±0.25	2.54±0.15	0.60±0.20	1.54±0.25	42.3
LRC10*TDAR003	3.0	5.08±0.25	2.54±0.15	0.60±0.20	1.04±0.25	42.3
LRC10*TDA****	4.0, 5.0	5.08±0.25	2.54±0.15	0.60±0.20	1.84±0.25	42.3
LRC10*TDA****	9.0, 10	5.08±0.25	2.54±0.15	0.60±0.20	1.29±0.25	42.3
LRC12*T**0M50G	0.50	6.35±0.25	3.00±0.20	0.60±0.20	2.68±0.25	59.13
LRC12*T**0M75G	0.75	6.35±0.25	3.00±0.20	0.60±0.20	2.48±0.25	59.13
LRC12*T*****G	1.0, 6.0	6.35±0.25	3.00±0.20	0.60±0.20	1.93±0.25	59.13
LRC12*T*****G	1.5, 6.5, 7.0	6.35±0.25	3.00±0.20	0.60±0.20	1.43±0.25	59.13
LRC12*T*****G	2.0, 2.5, 3.0, 3.5	6.35±0.25	3.00±0.20	0.60±0.20	1.18±0.25	59.13
LRC12*T*****G	4.0, 4.5	6.35±0.25	3.00±0.20	0.60±0.20	2.18±0.25	59.13
LRC12*T*****G	5.0, 6.0	6.35±0.25	3.00±0.20	0.60±0.20	1.93±0.25	59.13
LRC12*T*****G	8.0 - 10	6.35±0.25	3.00±0.20	0.60±0.20	1.18±0.25	59.13
LRC12*T*****G	11 - 15	6.35±0.25	3.00±0.20	0.60±0.20	1.18±0.25	59.13
LRC12*T*0M50	0.50	6.35±0.254	3.18±0.254	1.25±0.20	1.30±0.38	184.11
LRC12*T*0M75	0.75	6.35±0.254	3.18±0.254	0.75±0.20	1.30±0.38	131.11
LRC12*T*R001	1.00	6.35±0.254	3.18±0.254	0.65±0.20	1.30±0.38	110.85
LRC12*T*1M50	1.50	6.35±0.254	3.18±0.254	0.45±0.20	1.30±0.38	67.16
LRC12*T*R002	2.00	6.35±0.254	3.18±0.254	0.35±0.20	1.30±0.38	49.30
LRC12*T*2M50	2.50	6.35±0.254	3.18±0.254	0.65±0.20	1.30±0.38	97.95
LRC12*T*R003	3.00	6.35±0.254	3.18±0.254	0.55±0.20	1.30±0.38	83.49
LRC12*T*R004	4.00	6.35±0.254	3.18±0.254	0.45±0.20	1.30±0.38	62.59
LRC12*T*R005	5.00	6.35±0.254	3.18±0.254	0.35±0.20	1.30±0.38	49.84
LRC12*T*R006	6.00	6.35±0.254	3.18±0.254	0.32±0.20	1.30±0.38	41.76
LRC12*T*6M50	6.50	6.35±0.254	3.18±0.254	0.30±0.20	1.30±0.38	35.85
LRC12*T*R007	7.00	6.35±0.254	3.18±0.254	0.27±0.20	1.30±0.38	34.01
LRC12*T*R010	10.00	6.35±0.254	3.18±0.254	0.25±0.20	1.30±0.38	25.97

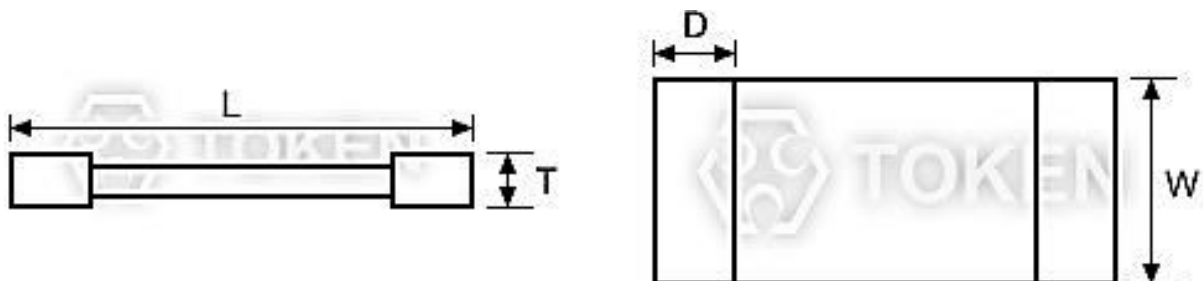

Chip 2512, 2010, 1206 Dimensions (LRC)

● Notice: TOKEN is capable of manufacturing the optional spec based on customer's requirement.

## ► Electrical Specifications

### Standard Electrical Specifications (LRC)

Type	Power Rating at 70°C	Operating Temp. Range	Resistance Tolerance (±%)	Resistance (mΩ)	TCR (±PPM/°C)
LRC06*TF0M50	1W	-55°C ~ +170°C	±1, ±3, ±5	0.5	±200
LRC06*TD****	1W			0.75 - 10	±50
LRC12*TD****	1W			0.5, 0.75, 1, 1.5, 2	±50
LRC12*TW****	1W			6, 6.5, 7	±75
LRC12*TE****	1W			4, 5, 10	±100
LRC12*TK****	1W			2.5, 3	±150
LRC12*TD****G	1W			11, 12, 13, 14, 15	±50

### High Power Rating Electrical Specifications (LRC)

Type	Power Rating at 70°C	Operating Temp. Range	Resistance Tolerance (± %)	Resistance (mΩ)	TCR (±PPM/°C)
LRC10*TEA0M50	1.5W	-55°C ~ +170°C	±1, ±3, ±5	0.5	±100
LRC10*TDA****	1.5W			0.75 - 10	±50
LRC12*TDS****	2W			0.5, 0.75, 1, 1.5, 2	±50
LRC12*TWS****	2W			6, 6.5, 7	±75
LRC12*TES****	2W			4, 5, 10	±100
LRC12*TKS****	2W			2.5, 3	±150
LRC12*TDS****G	2W			6.5, 7, 8, 9, 10	±50
LRC12*TDB****G	2.5W			4, 4.5, 5, 6	±50
LRC12*TDR****G	3W			1, 1.5, 2, 2.5, 3, 3.5	±50
LRC12*TER****G	3W			0.5, 0.75	±100

● Remark : Operating Current  $I = \sqrt{(P / R)}$  , Operating Voltage  $V = \sqrt{(P * R)}$

## Environmental Characteristics

### Environmental Characteristics (LRC)

Item	Specification		Test Method
	Black coating	Green coating	
Thermal Shock	±0.5%	±1%	-55°C~150°C, 100 cycles. MIL-STD-202 Method 107G
Short Time Overload	±0.5%	±1%	5*Rated Power for 5 seconds. JIS-C-5202-5.5
Endurance	±1%	±1%	70±2°C, Max. working voltage for 1000 hrs with 1.5 hrs and 0.5 hrs
Dry Heat	±1%	±1%	at +170°C for 1000 hrs
Resistance to Soldering Heat	±0.5%	±1%	260±5°C, for 10 seconds. MIL-STD-202F Method 210E
Solderability	95% min coverage		245±5°C for 3 seconds. MIL-STD-202F Method 210E
Temperature Coefficient of Resistance	As Spec.		+25/-55/+25/+125/+25°C. MIL-STD-202 Method 304

- Rated continuous Working Voltage (RCWV) =  $\sqrt{\text{Power Rating} \times \text{Resistance Value } (\Omega)}$  or Max. Operating voltage whichever is lower.
- Green coating can't be work with wave soldering bath.
- Humidity < 80%RH; Storage Temperature: 25±3°C

### Soldering Condition (LRC)

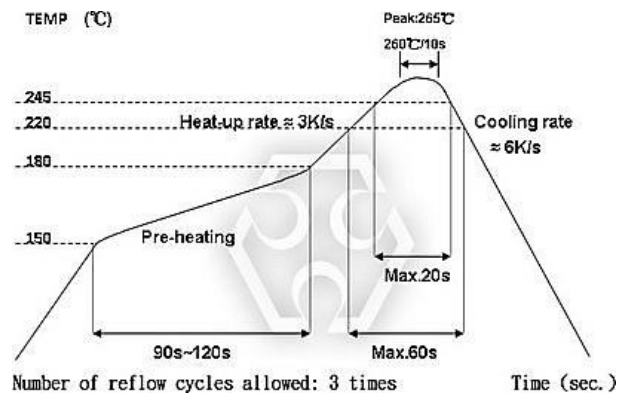

Green coating "Reflow Air Convection" is available  
Green coating can't be working with wave soldering bath

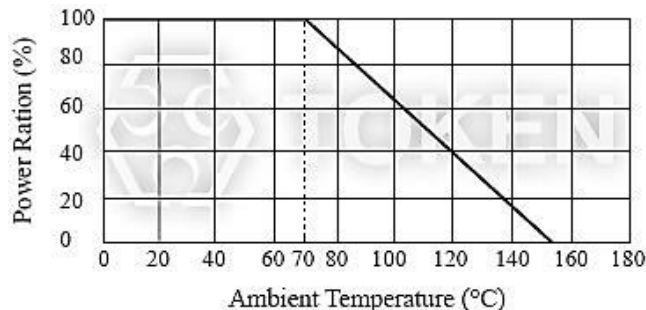

► Pad Layout

4-Wire Precision Measurement (LRC)

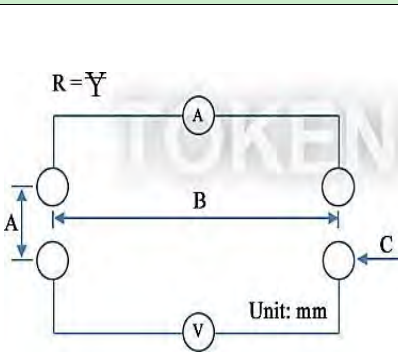
Figure	Type	A	B	C	Excitation Current (A)	Resistance (Ω)
 <p>4-Wire Precision Measurement</p> <p>Unit: mm</p>	LRC12 Black Coating	1.5	5.4	Φ0.5	3A	0.5m ~ 1.5 m
	LRC12 Black Coating	1.5	5.4	Φ0.5	1A	2m ~10m
	LRC12 Green Coating	1.5	5.4	Φ0.5	3A	0.5m ~ 1.5m
	LRC12 Green Coating	1.5	5.4	Φ0.5	1A	2m ~ 15m
	LRC06	1.25	2.6	Φ0.5	3A	0.5m ~ 1.5m
	LRC06	1.25	2.6	Φ0.5	1A	2m ~ 10m
	LRC10	1.2	4.32	Φ0.5	3A	0.5m ~ 1.5m
	LRC10	1.2	4.32	Φ0.5	1A	2m ~ 10m

● Note: Equipment: ADEX AX-1152D DC Low Ohm Meter

## 4-Wire Pad Layout (LRC)

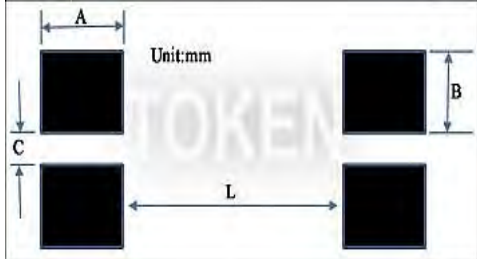
Figure	Type	Resistance ( $\Omega$ )	A	B	C	L
 <p><b>4-Wire Pad Layout</b> (recommended for precision current sensing)</p>	<b>LRC12 Black Coating</b>	-	1.0	2.7	2.95	1.45
	<b>LRC12 Green Coating</b>	0M50	3.13	1.2	1.0	0.52
		0M75	2.93	1.2	1.0	0.94
		R001	2.38	1.2	1.0	2.04
		1M5	1.88	1.2	1.0	3.04
		R002~3M5	1.63	1.2	1.0	3.54
		R004~4M5	2.63	1.2	1.0	1.54
		R005~R006	2.38	1.2	1.0	2.04
		6M5~R007	1.88	1.2	1.0	3.04
		R008~R015	1.63	1.2	1.0	3.54
	<b>LRC10</b>	0M50	2.61	1.045	0.8	0.60
		0M75	2.49	1.045	0.8	0.80
		R001	2.29	1.045	0.8	0.95
		R002	1.99	1.045	0.8	1.55
		R003	1.49	1.045	0.8	2.55
		R004~R005	2.29	1.045	0.8	0.95
		R006~R008	1.99	1.045	0.8	1.55
		R009~R010	1.74	1.045	0.8	2.05
		<b>LRC06</b>	0M50	1.80	0.7	0.5
	0M75		1.68	0.7	0.5	0.55
	R001		1.55	0.7	0.5	0.55
	1M2		1.35	0.7	0.5	0.95
	1M5		1.35	0.7	0.5	1.55
	R002~R003		1.05	0.7	0.5	1.55
	3M5~R006		1.55	0.7	0.5	0.55
	R007~R009		1.35	0.7	0.5	0.95
	R010		1.05	0.7	0.5	1.55

● Note: No circuits between pads to avoid short circuit

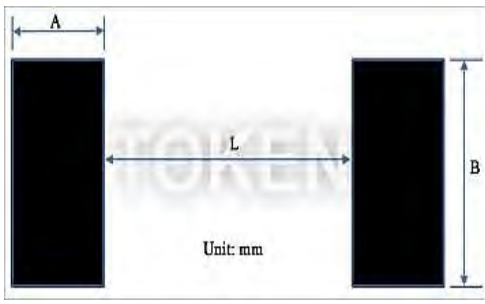

## 2-Wire Pad Layout (LRC)

Figure	Type	Resistance ( $\Omega$ )	A	B	L
 <p style="text-align: center;">2-Wire Pad Layout</p>	LRC12 Black Coating	-	2.7	3.6	2.95
	LRC12 Green Coating	0M50	3.13	3.4	0.52
		0M75	2.93	3.4	0.94
		R001	2.38	3.4	2.04
		1M5	1.88	3.4	3.04
		R002~3M5	1.63	3.4	3.54
		R004~4M5	2.63	3.4	1.54
		R005~R006	2.38	3.4	2.04
		6M5~R007	1.88	3.4	3.04
	LRC10	R008~R015	1.63	3.4	3.54
		0M50	2.61	2.89	0.60
		0M75	2.49	2.89	0.80
		R001	2.29	2.89	0.95
		R002	1.99	2.89	1.55
		R003	1.49	2.89	2.55
		R004~R005	2.29	2.89	0.95
		R006~R008	1.99	2.89	1.55
	LRC06	R009~R010	1.74	2.89	2.05
		0M50	1.80	1.90	0.55
		0M75	1.68	1.90	0.55
		R001	1.55	1.90	0.55
		1M2	1.35	1.90	0.95
		1M5	1.35	1.90	1.55
		R002~R003	1.05	1.90	1.55
		3M5~R006	1.55	1.90	0.55
	R007~R009	1.35	1.90	0.95	
	R010	1.05	1.90	1.55	

● Note: No circuits between pads to avoid short circuit

► Reel & Tape

Emboss Plastic Tape Specifications (LRC)

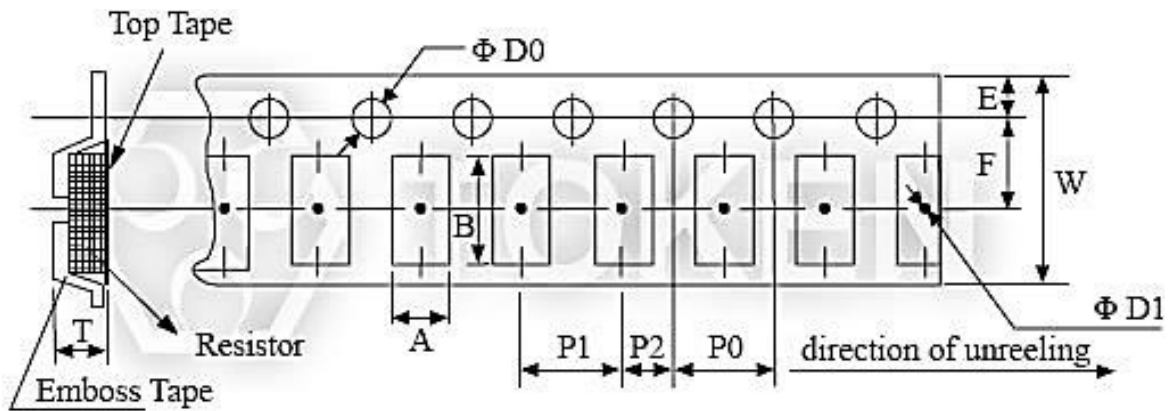

Emboss Plastic Tape Specifications

Type	Resistance (mΩ)	P0 (mm)	P1 (mm)	P2 (mm)	ΦD0 (mm)	ΦD1 (mm)	T (mm)
LRC06	0.5 - 10	4.0±0.1	4.0±0.1	2.0±0.05	1.55±0.05	1.0min	0.87±0.1
LRC10	0.5 - 10	4.0±0.1	4.0±0.1	2.0±0.05	1.55±0.05	1.4min	0.85±0.1
LRC12	0.50 - 0.75	4.0±0.1	4.0±0.1	2.0±0.05	1.55±0.05	1.4min.	1.45±0.2
	1 - 10	4.0±0.1	4.0±0.1	2.0±0.05	1.55±0.05	1.4min.	0.81±0.1
LR12 (G)	0.50 - 15	4.0±0.1	4.0±0.1	2.0±0.05	1.55±0.05	1.4min	0.85±0.1

- The cumulative tolerance of 10 sprocket whole pitch is ±0.2mm.
- Carrier camber shall be not more than 1mm per 100mm through a length of 250mm.
- A & B measured 0.3mm from the bottom of the packet.
- t measured at a point on the inside bottom of the packet to the top surface of the carrier.
- Pocket position relative to sprocket hole is measured as the true position of the pocket and not the pocket hole.

**Order Codes**

**Order Codes (LRC)**

LRC	12		H		TR		D				R011		G		
Part Type	Dimensions (L×W)(mm)		Resistance Tolerance (%)		Package		TCR (PPM/°C)		Power Rating (W)		Resistance (Ω)		Protective Coating		
	12	6.3×3.1	EIA2512	J	±5	TR	Taping Reel	D	±50		Standard	0m50	0.00050		Black Coating
	10	5.1×2.5	EIA2010	H	±3			W	±75	A	1.5	0m75	0.00075		
	06	3.2×1.6	EIA1206	F	±1			E	±100	S	2	1m50	0.00150	G	Green Coating
								F	±200	R	3	R011	0.01100	**2010/1206	No coating / marking
								K	±150	B	2.5	R002	0.00200		
												R020	0.02000		

**Resistance codes example (3 Marking)**

Resistance	0.39mΩ	0.5mΩ	0.75mΩ	330mΩ	5.1Ω
Codes	M39	M50	M75	R33	5R1

**Resistance codes example (4 Marking)**

Resistance	1mΩ	1.5mΩ	2mΩ	7mΩ	10mΩ
Codes	R001	1M50	R002	R007	R010

## ► General Information

### Your Current Options - Token Current Sense

As the world becomes more and more technology-driven, the uses for current sensing components will continue to increase. The need for even lower resistance value ranges is already becoming evident, as is the need for these resistors to handle more power. The industry-wide trend is the emergence of smaller and smaller products.

Token Electronics offers a wide variety of current sensing products from the industry to military standards, such as current sense in Thin-Film / Thick-Film Technology, Bare Element Resistors, and Open Air Shunts. This enables Token to present an astounding number of possible solutions for any circuit design needs.

### Applications of Current Detecting Components

Token's TCS and CS Series unique form factor provides automotive designers with several advantages. Both TCS and CS Series are ideal for applications involving window lift motors, fuel pump systems, seat belt pretensioners, and pulse width modulator feedback.

The wider resistive element and lower resistance enables higher current to pass through the device. Token's LRC ultra low Ohmic metal strip chip series provides the inherent ability to flex slightly and offers stress relief during extreme temperature cycling on typical or metal substrates. This LRC series is suitable for switch power supply applications (DC-DC Converter, Charger, and Adaptor) and power management of monitor.

The open air design of bare element resistor LRA and LRB Series provide a far cooler operation by allowing more air flow under the resistive element to keep excess heat from being transmitted to the PC board. They are suitable for high power AC/DC detection of power supply circuit.

Token axial moulded BWL series provides power rating up to 10 watts and lower resistance  $0.005\Omega$ , is ideal for all types of current sensing applications including switching and linear power supplies, instruments and power amplifiers.

Token standard current sensing components can be replacement for Vishay, IRC, Ohmite, KOA, Yageo devices with fast delivery and more competitive price. Contact us with your specific needs.