

Version:
June 26, 2017



TOKEN

(TCPWCH) Common Mode Chokes

Token Electronics Industry Co., Ltd.

Taiwan: No.137, Sec. 1, Zhongxing Rd., Wugu District,
New Taipei City, Taiwan, R.O.C. 24872
Tel: +886 2981 0109 Fax: +886 2988 7487

China: 12F, Zhong Xing Industry Bld., Chuang Ye Road,
Nan Shan District, Shen Zhen City,
Guang Dong, China 518054
Tel: +86 755 26055363; Fax: +86 755 26055365

[Web: www.token.com.tw](http://www.token.com.tw)

[Email: rfq@token.com.tw](mailto:rfq@token.com.tw)



▶ Product Introduction

Token Extends common mode chokes in high speed data links for USB 3.0.

Features & Applications :

- Lowprofile and very small size SMD Design.
- Wound Chip constructure with standard 0504 and 0805 size.
- Very high self-resonance frequency enables high cut-off frequency.
- Matching to characteristic impedance enables good transmission of high-speed signals.

In the electronics environment seen by today there are numerous sources of radio frequency interference (RFI) and electromagnetic interference (EMI). This is due in large component to the increased use of RF technology. These types of interference result in the need for common mode filtering in applications utilizing differential interfaces. Token common mode chokes help maintain the integrity of high speed communications and may be necessary for conformance with international regulatory standards.



Token (TCPWCH-1210HS/2012HS) Series SMD Common Mode Choke Coils are for high-speed and ultra-high-speed differential signal lines such as LVDS, IEEE1394/FireWire, USB, etc. The chip type (TCPWCH-1210HS/2012HS) series provides EMI suppression in case sizes 0504, and 0805. The SMD Common Mode Chokes are useful in a number of applications, such as power supply units, cellular baseband, audio circuit, CPU, interface, display panel, remote controllers, and inverters.

Updated News! Token has expanded its (TCPWCH-1210HS/2012HS) series common mode chokes to include the TCPWCH-1210HS-900TR and TCPWCH-2012HS-900TR, designed to address the unique noise issues of higher frequencies of USB 3.0 (SuperSpeed) devices. The Token TCPWCH-1210HS/2012HS-900TR, matches the characteristic impedance of the 90Ω USB3.0 standard. The common mode chokes utilize winding technology using EMI Suppression Ferrite cores processes to successfully boost the cut-off frequency in the transmission characteristics of the choke coils from the cut-off frequency featured by previous series to a higher, enabling SuperSpeed signals to be transmitted.

All (TCPWCH) series comes a wide variety of options to meet your needs with halogen free and feature RoHS Directive. Token is able to customize and manufacture your request. Please contact our sales or link to Token official website "[SMD Balun Transformers](http://www.token.com.tw)" for more information.



► Config. & Dim.

Configurations & Dimensions (TCPWCH-1210HS, TCPWCH-2012HS)

UNIT: mm (inch)

SIZE CODE	A	B	C	D1 TYP	D2 TYP	F TYP	G TYP	H TYP	I TYP
TCPWCH-1210HS (0504)	1.20±0.20 (0.047±0.008)	1.00±0.20 (0.069±0.008)	0.035±0.20 (0.110±0.008)	0.36 (0.014)	0.38 (0.015)	0.30 (0.012)	1.20 (0.047)	0.60 (0.024)	1.50 (0.059)
TCPWCH-2012HS (0805)	2.00±0.20 (0.079±0.008)	1.20±0.20 (0.047±0.008)	1.20±0.20 (0.047±0.008)	0.45 (0.018)	0.40 (0.016)	0.40 (0.016)	1.20 (0.047)	0.80 (0.031)	2.60 (0.102)

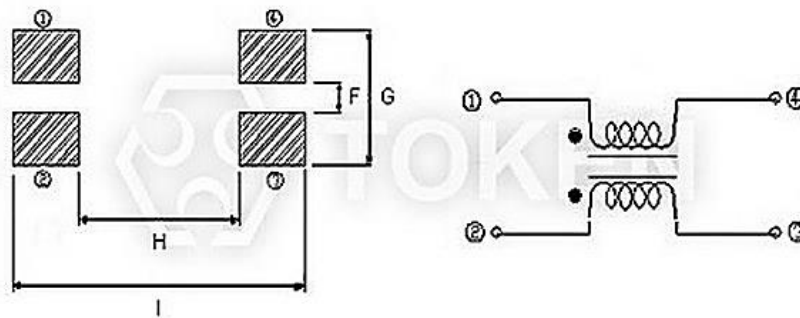
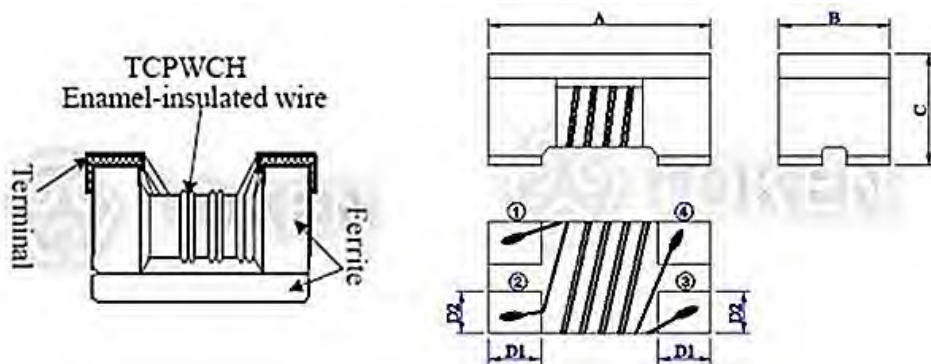

Common mode filter (TCPWCH-1210HS, TCPWCH-2012HS) Structure diagram Unit: mm (Inch)

▶ 1210HS Specifications

Electrical Characteristics (TCPWCH-1210HS)

Part Number	Impedance (Ω) 10MHz	Tolerance $\pm\%$	CUT-OFF FREQUENCY (GHz) Typ.	Rated Voltage (Ω) Max.	DC Resistance (mA) Max.
TCPWCH-1210HS-250TR	25	25%	7.5	0.25	420
TCPWCH-1210HS-600TR	60	25%	6.0	0.25	400
TCPWCH-1210HS-900TR	90	25%	6.0	0.30	400

Electrical Characteristics Graph TCPWCH-1210HS-250TR

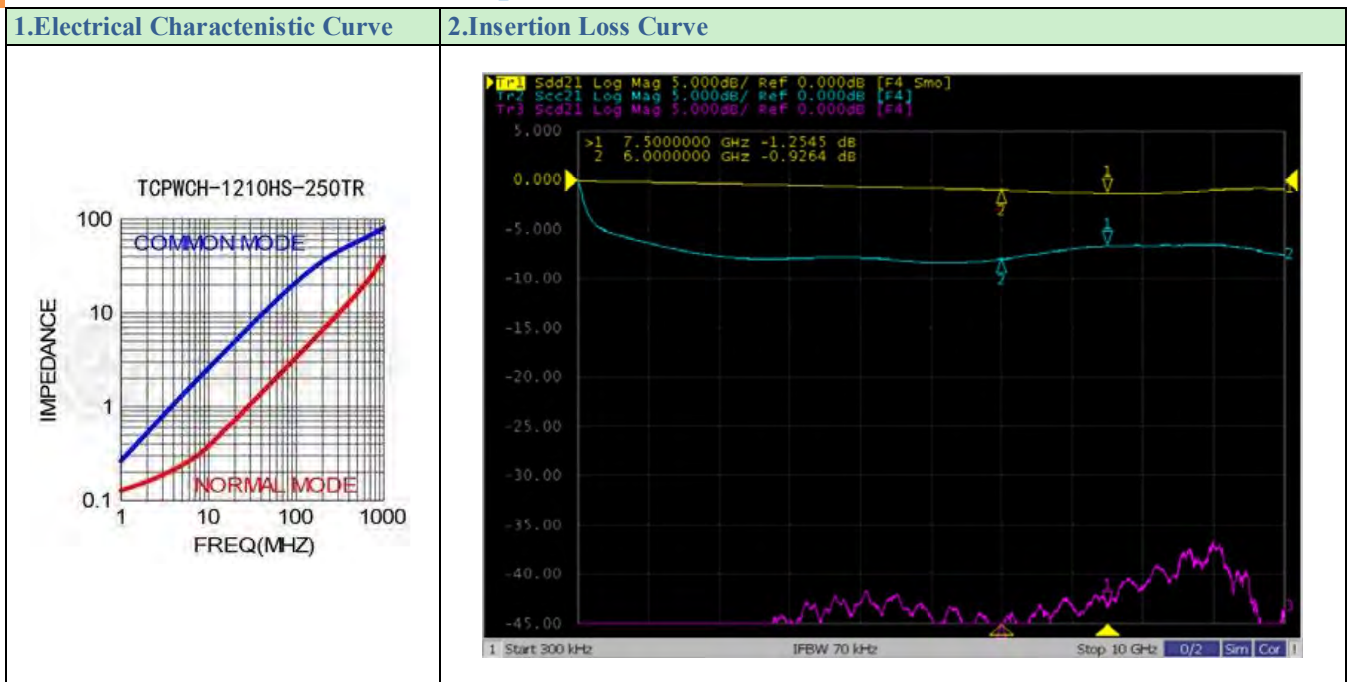

Electrical Characteristics Graph TCPWCH-1210HS-600TR

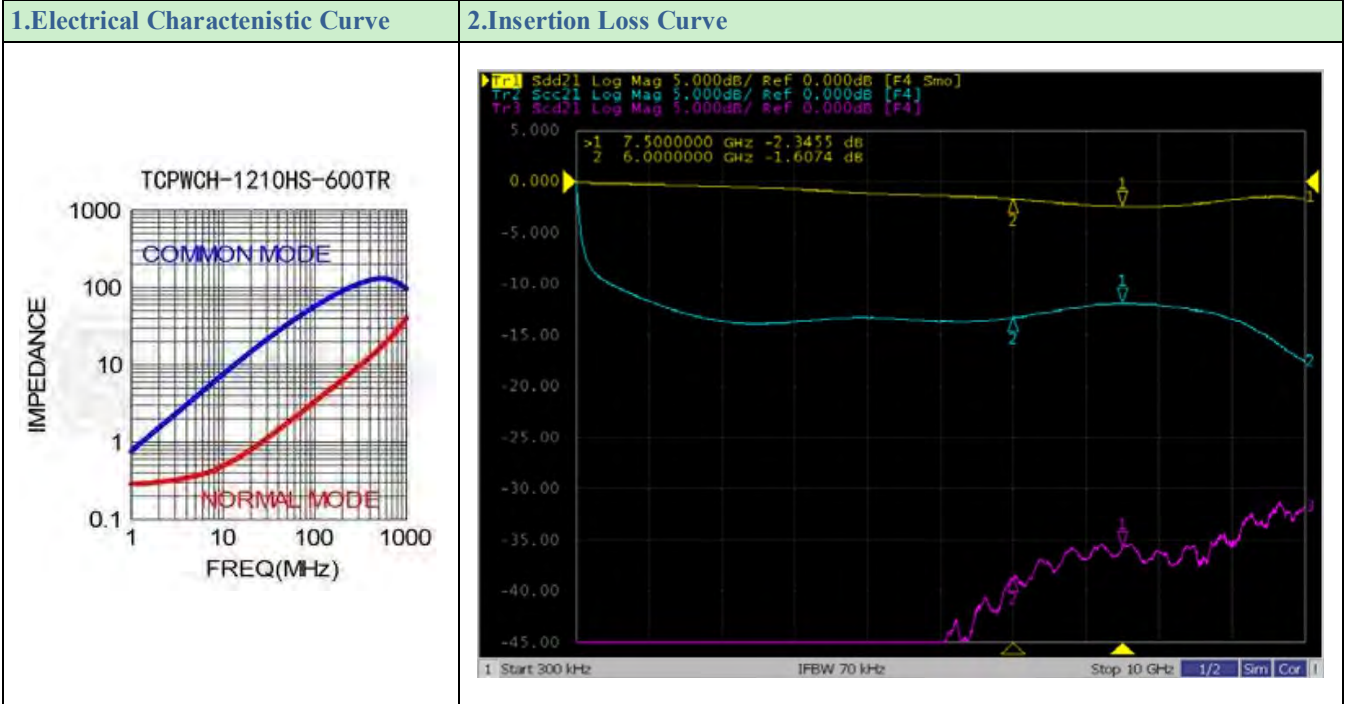

Electrical Characteristics Graph TCPWCH-1210HS-900TR

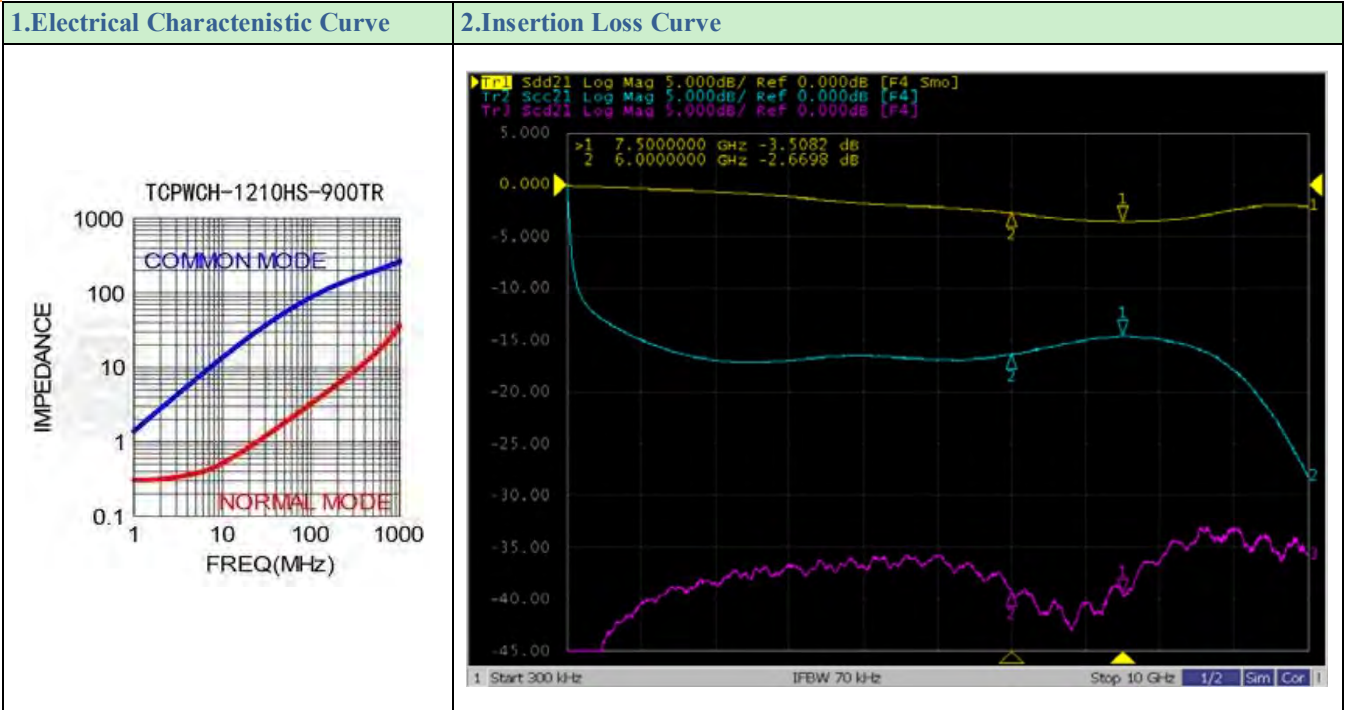

► 2012HS Specifications

Electrical Characteristics (TCPWCH-2012HS)

Part Number	Impedance (Ω) 10MHz	Tolerance $\pm\%$	CUT-OFF FREQUENCY (GHz) Typ.	Rated Voltage (Ω) Max.	DC Resistance (mA) Max.
TCPWCH-2012HS-120TR	12	25%	7.5	0.20	450
TCPWCH-2012HS-240TR	24	25%	7.5	0.25	420
TCPWCH-2012HS-320TR	32	25%	7.5	0.25	400
TCPWCH-2012HS-670TR	67	25%	6.0	0.25	400
TCPWCH-2012HS-900TR	90	25%	6.0	0.30	400

Electrical Characteristics Graph TCPWCH-2012HS-120TR

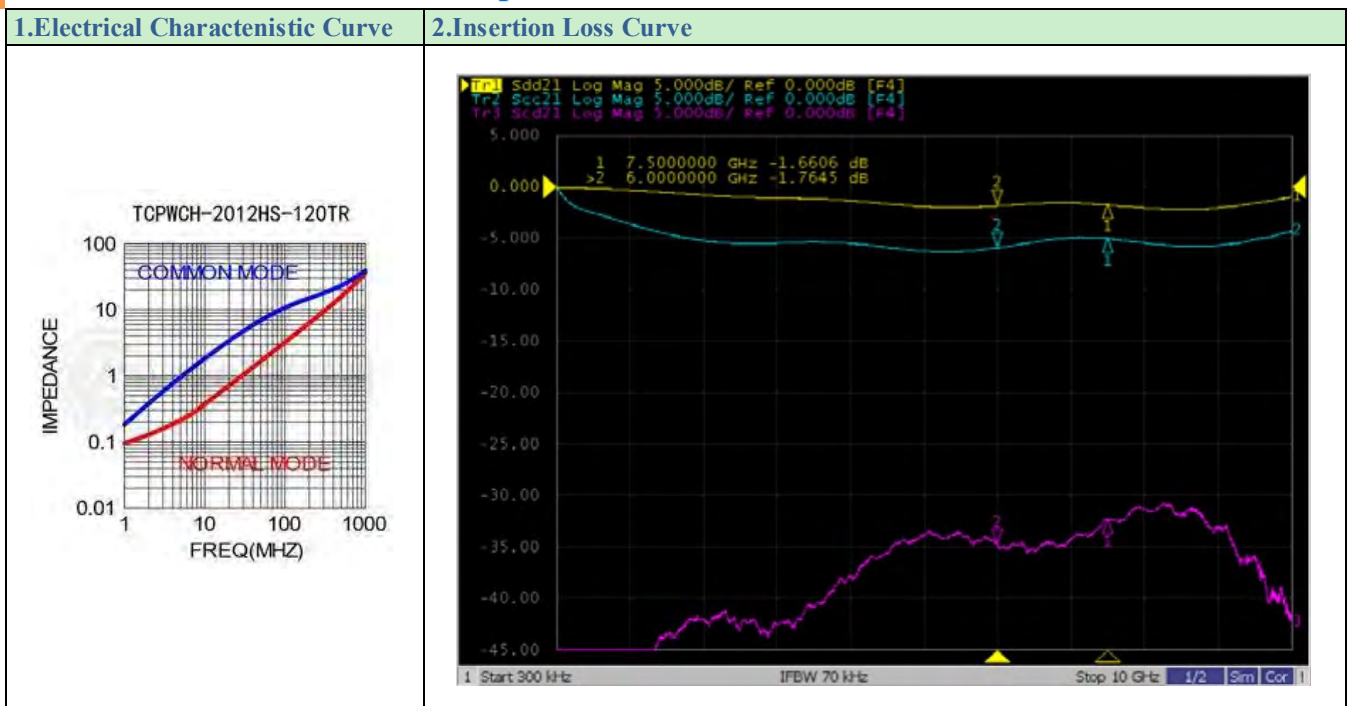

Electrical Characteristics Graph TCPWCH-2012HS-240TR

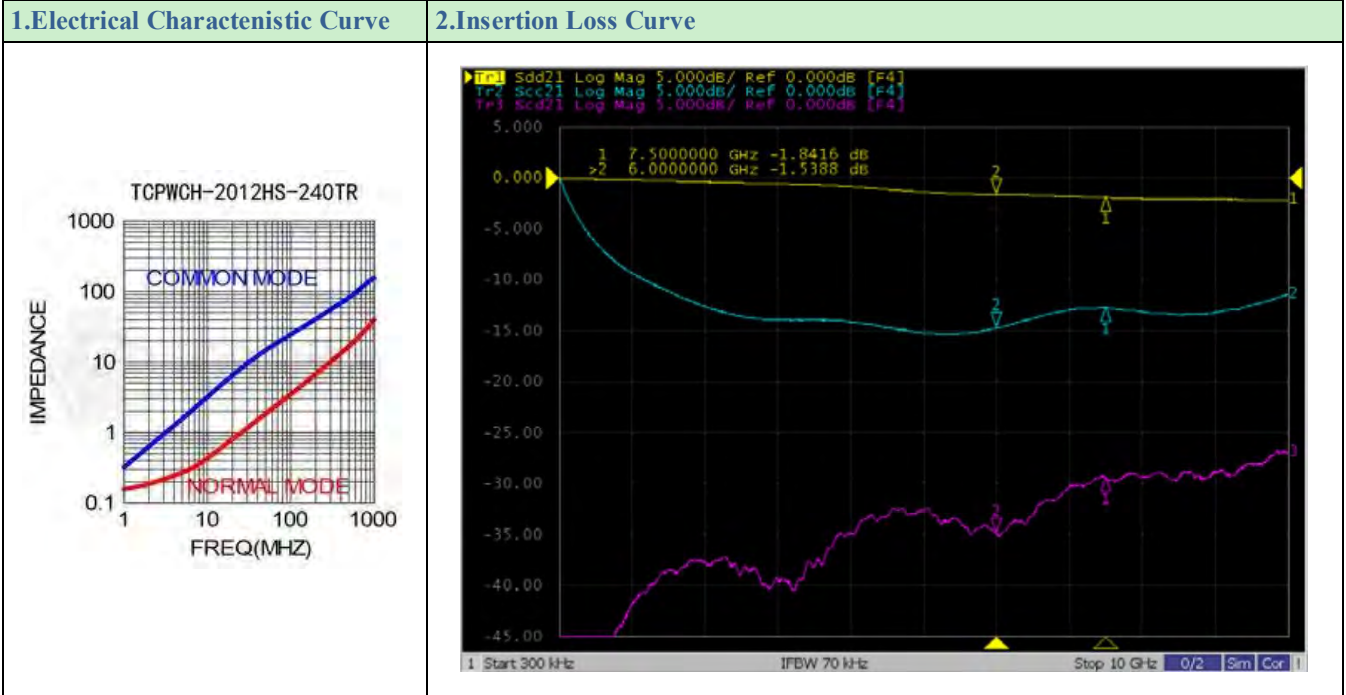

Electrical Characteristics Graph TCPWCH-2012HS-320TR

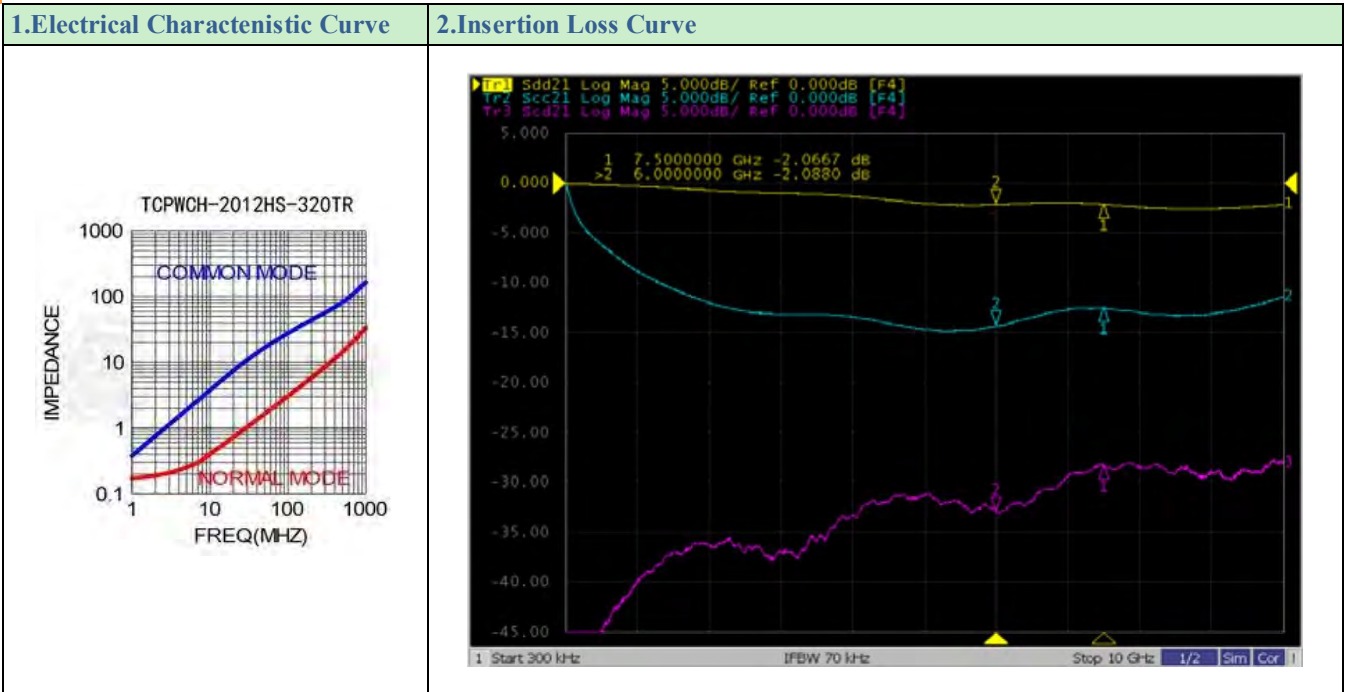

Electrical Characteristics Graph TCPWCH-2012HS-670TR

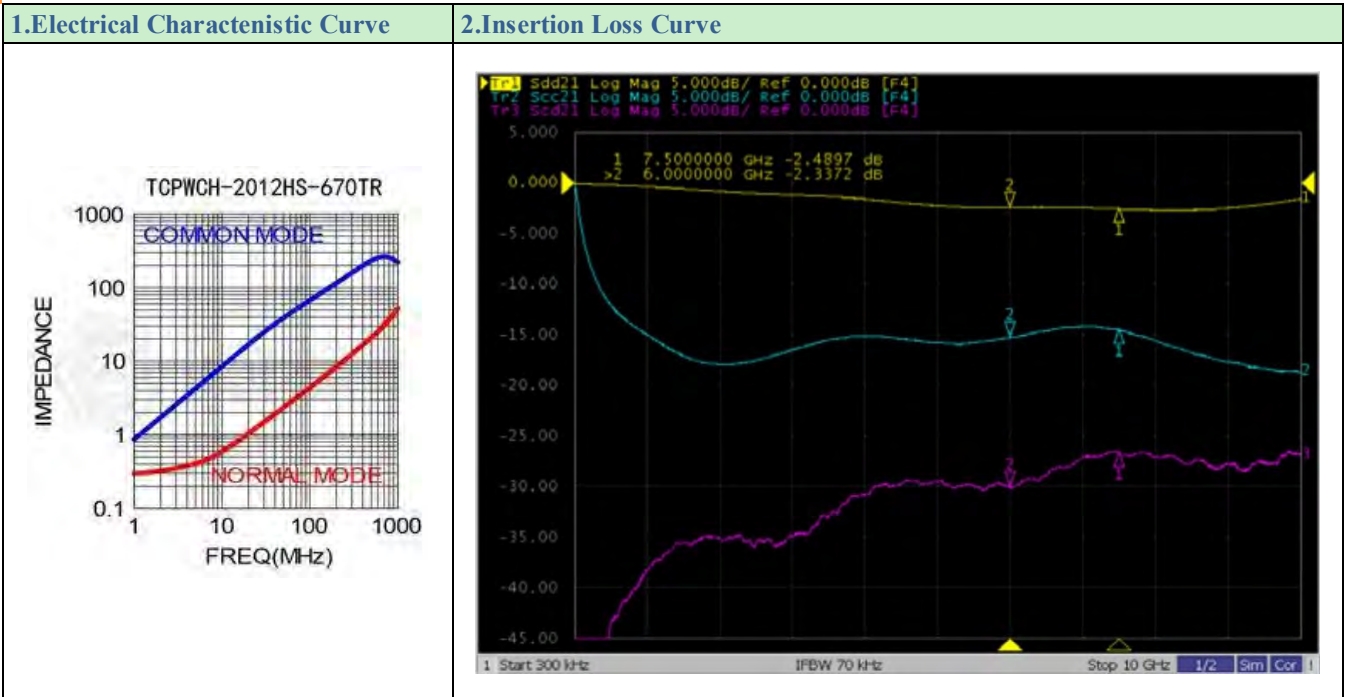

Electrical Characteristics Graph TCPWCH-2012HS-900TR

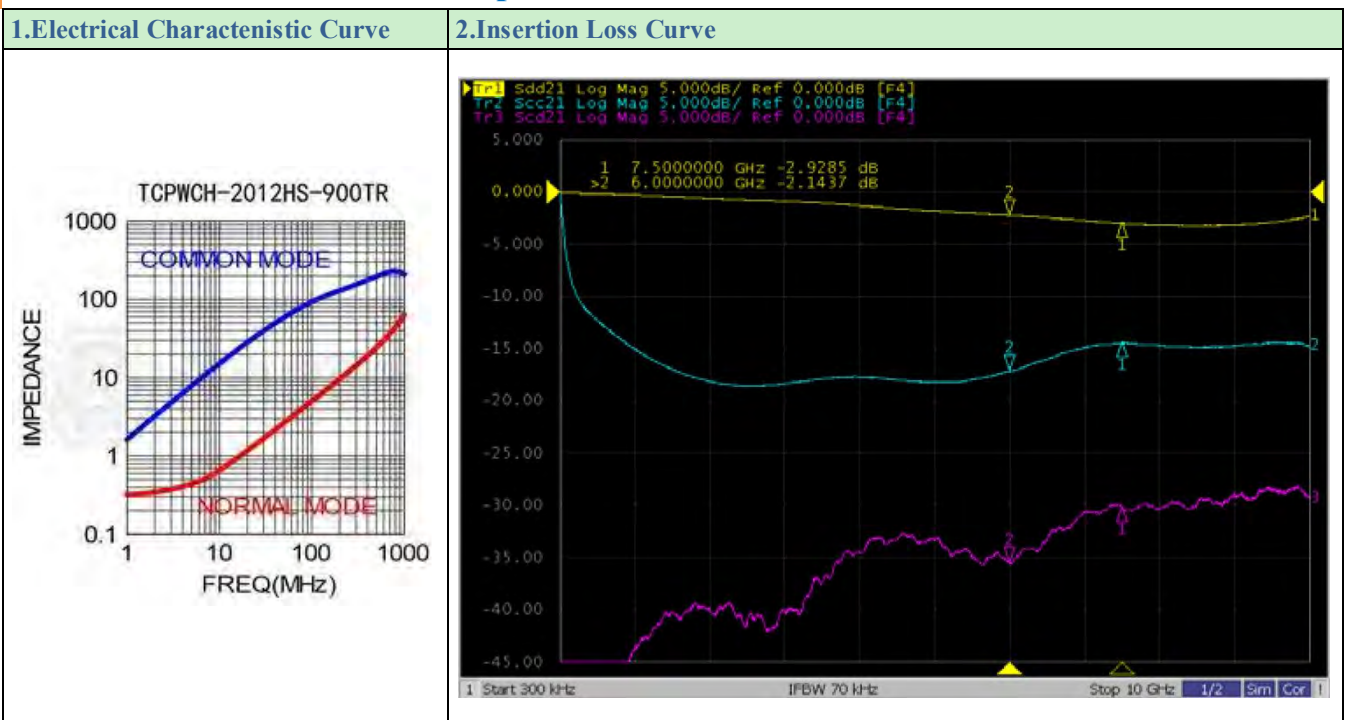

Order Codes

Order Codes (TCPWC)

TCPWC	H	-	1210			HS	-	250	TR		
Part Number	Shielding Type		Dimensions (mm)			Purpose		Impedance (Ω)		Package	
TCPWC	H	Shielding	1210	1.00×0.20×0.035	EIA0504	HS	High speed	120	12Ω	P	Bulk
			2012	2.00×1.20×1.20	EIA0805			250	25Ω	TR	Taping Reel
								320	32Ω		
								900	90Ω		

General Information

Applications of Baluns

In a **RF balun transformer**, one pair of terminals is balanced, that is, the currents are equal in magnitude and opposite in phase. The other pair of terminals is unbalanced; one side is connected to electrical ground and the other carries the signal. Balun transformers can be used between various parts of a wireless or cable communications system. Some common applications denotes as following:

- Television receiver (Balanced) - coaxial cable network or Coaxial antenna system (Unbalanced)
- FM broadcast receiver (Balanced) - Coaxial antenna system (Unbalanced)
- Dipole antenna (Balanced) - Coaxial transmission line (Unbalanced)
- Parallel-wire transmission line (Balanced) - Coaxial transmitter output, or Coaxial receiver input (Unbalanced)

Token's baluns provide impedance transformation in addition to conversion between balanced and unbalanced signal modes. Most television and FM broadcast receivers are designed for 300-ohm balanced systems, while coaxial cables have characteristic impedances of 50 or 75 ohms. Impedance-transformer baluns with larger ratios are available and used to match high-impedance balanced antennas to low-impedance unbalanced wireless receivers, transmitters, or transceivers.

